

BAR Manual

MM01 17/10

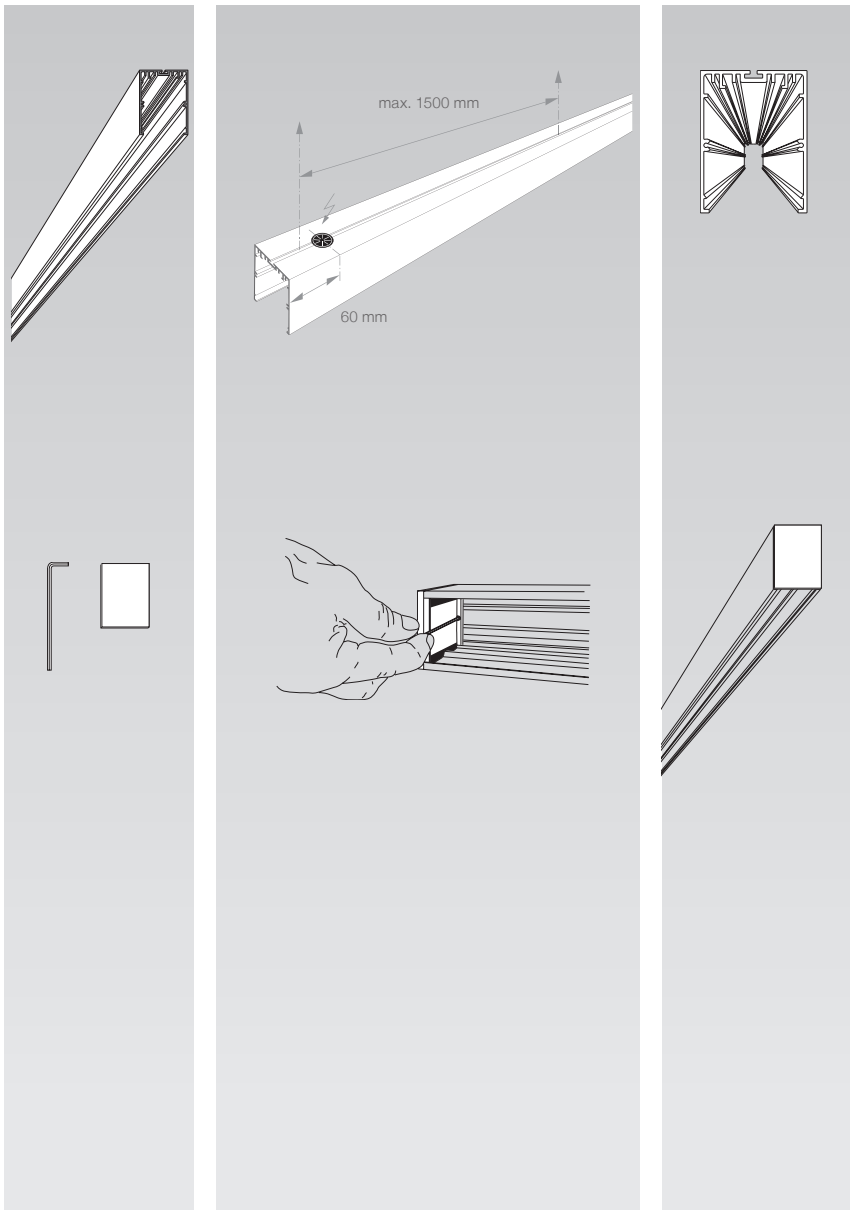

DE Die Produkte-Abbildungen und Beschreibungen entsprechen dem Stand zum Zeitpunkt der Drucklegung. Technische, formale oder massliche Änderungen sowie Irrtümer sind vorbehalten **EN** The product images and description correspond to the state at time of printing. Technical, formal or dimensional information are subject to change **FR** Les illustrations et descriptifs correspondent aux spécifications en vigueur lors de l'impression. Des corrections techniques, formelles et dimensionnelles pourront être apportées ultérieurement **IT** Le figure dei prodotti e le descrizioni corrispondono allo stato al momento della stampa. Fatte salve eventuali modifiche tecniche, formali o dimensionali nonché eventuali errori.

BAR Manual

MM01 17/10

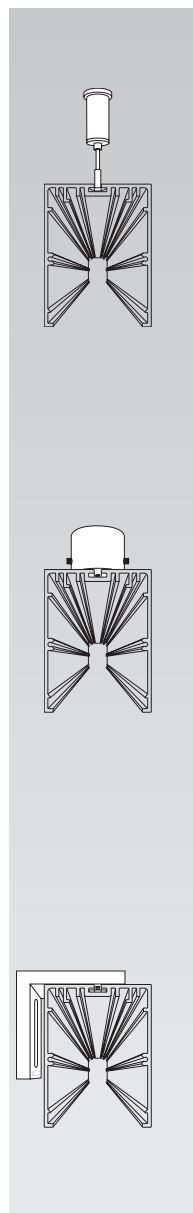
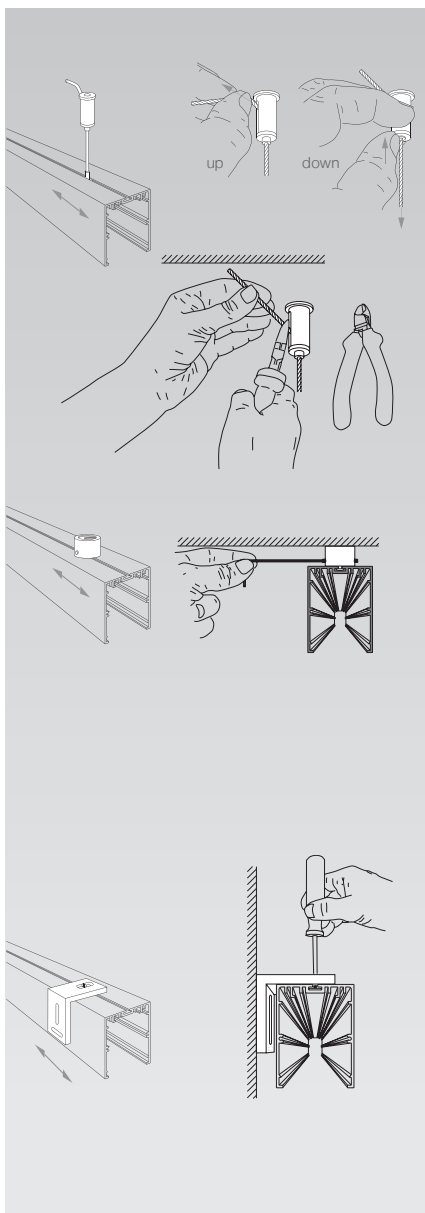
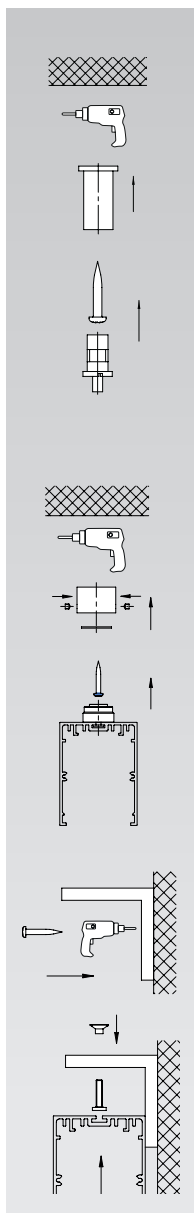

BAR Manual

MM01 17/10

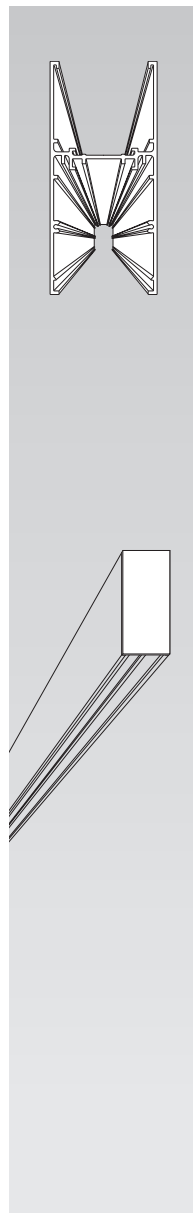
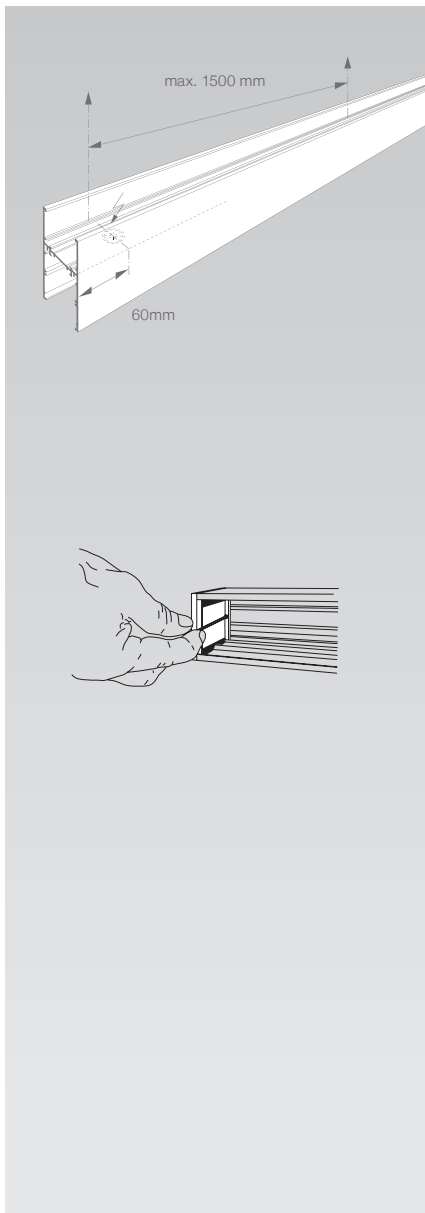
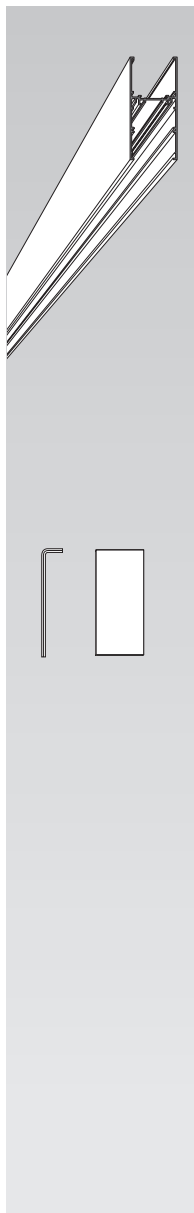

BAR Manual

MM01 17/10

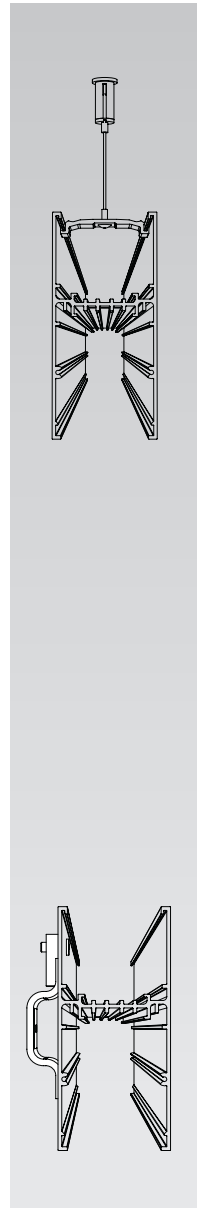
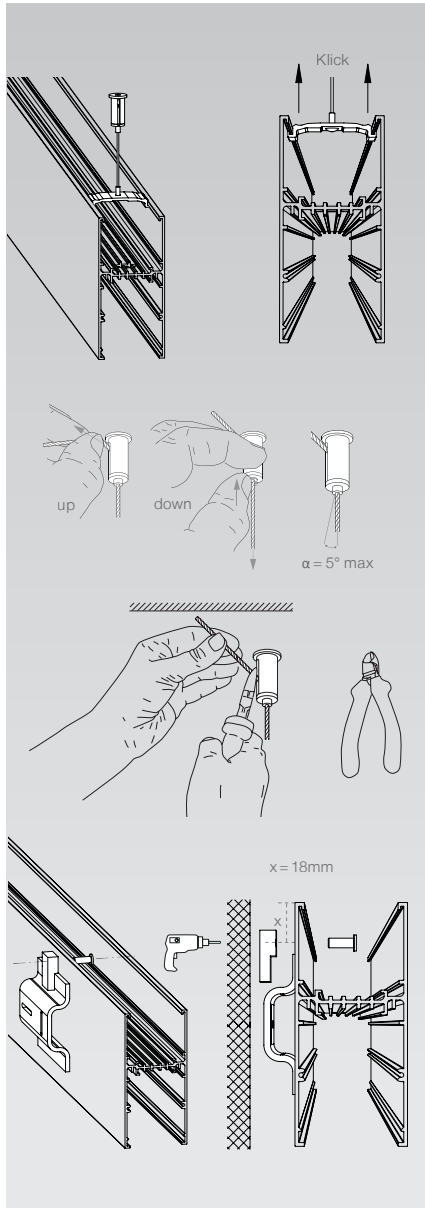
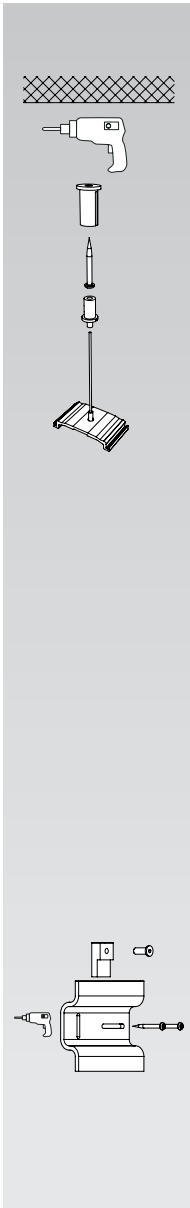

BAR Manual

MM01 17/10

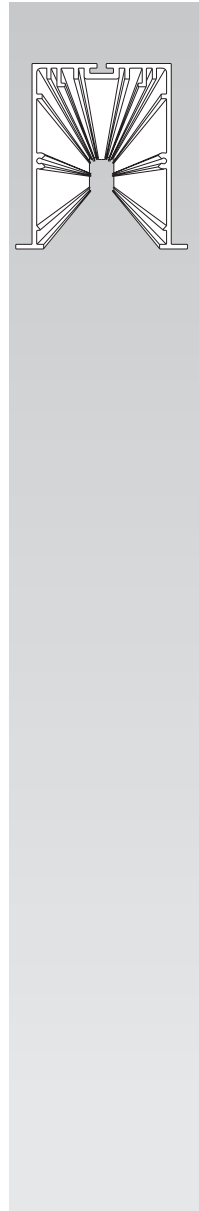
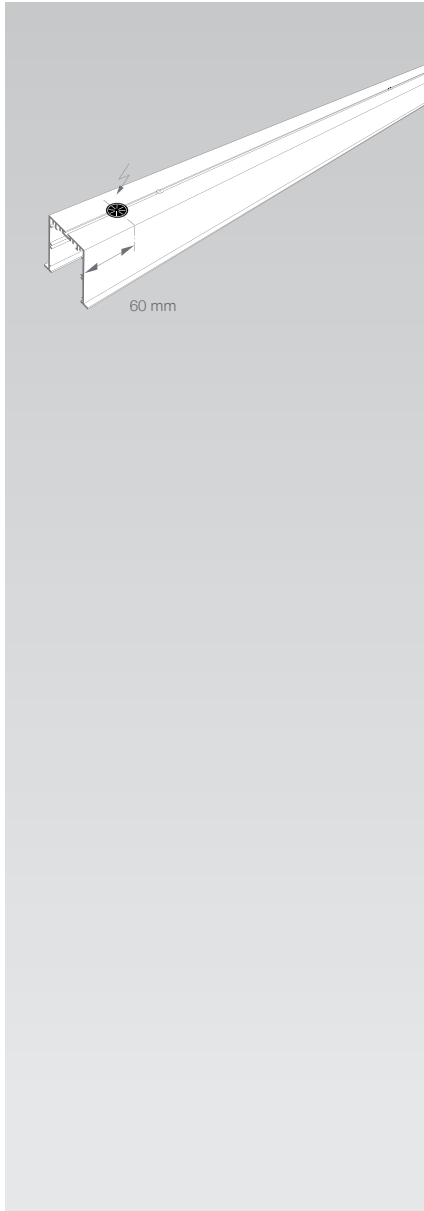
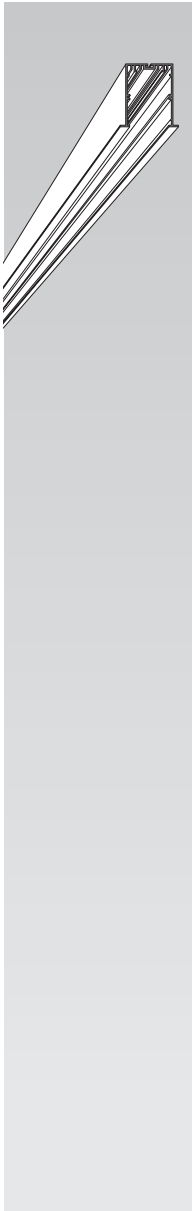

BAR Manual

MM01 17/10

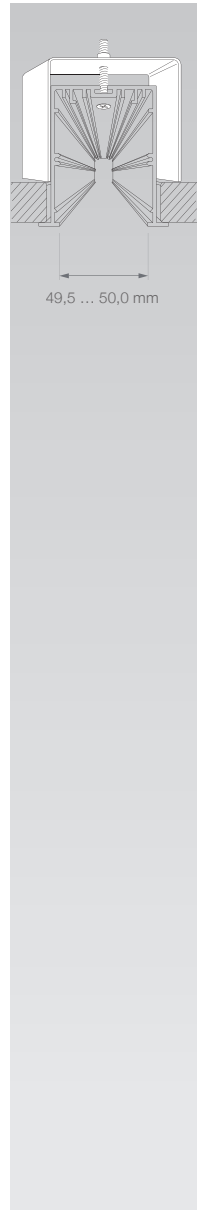
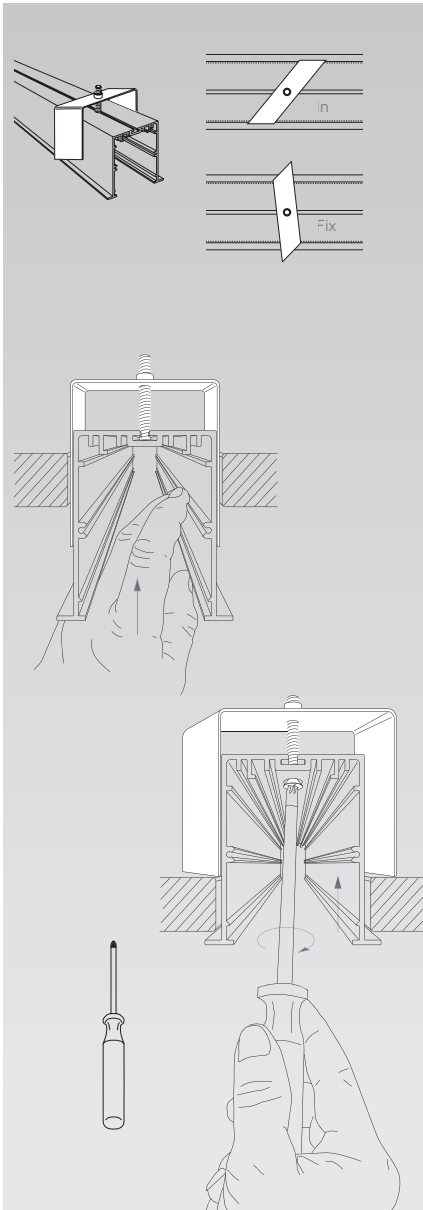
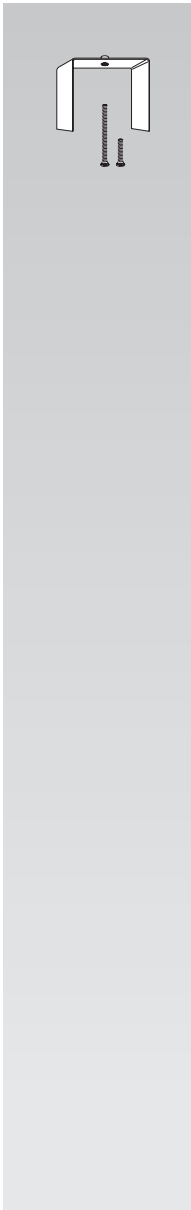

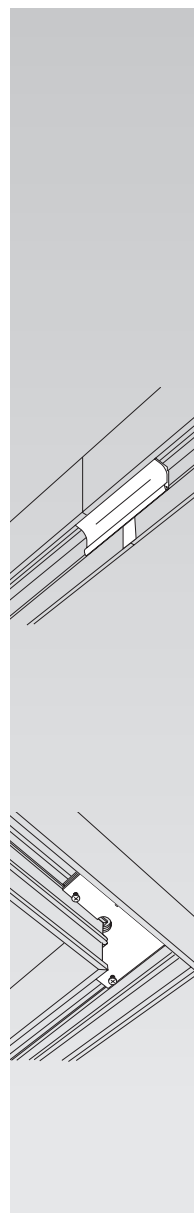
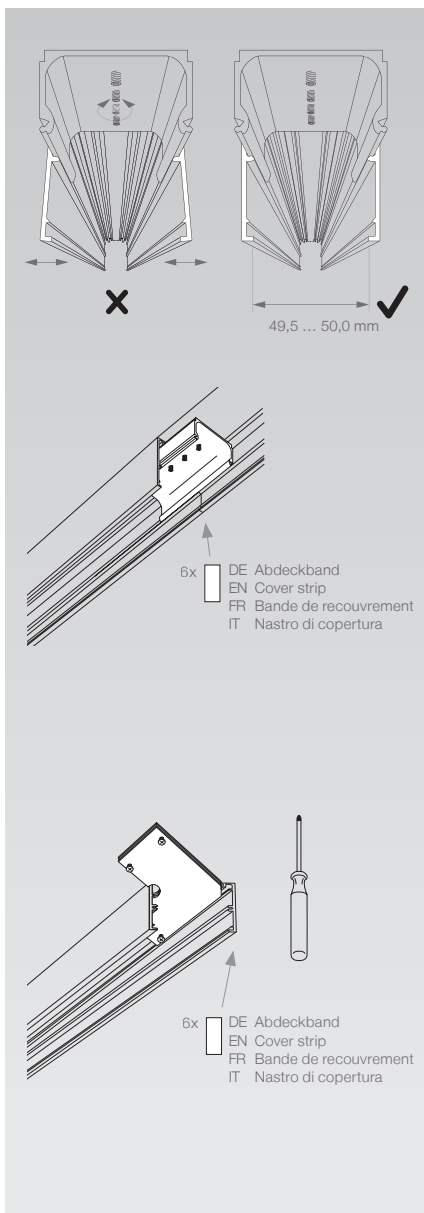
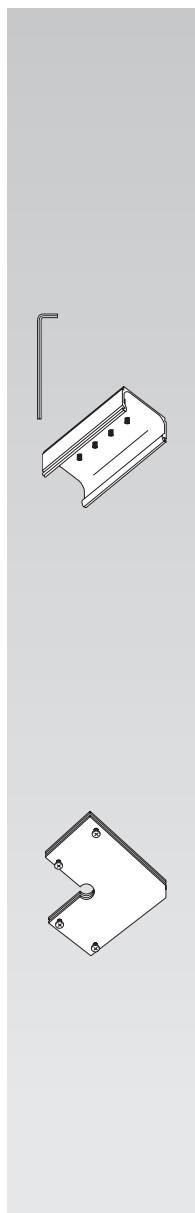

BAR Manual

MM01 17/10

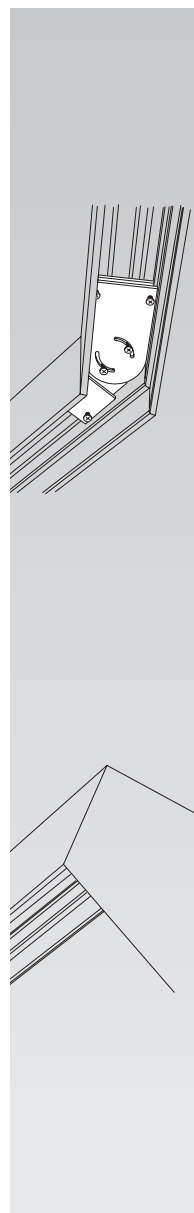
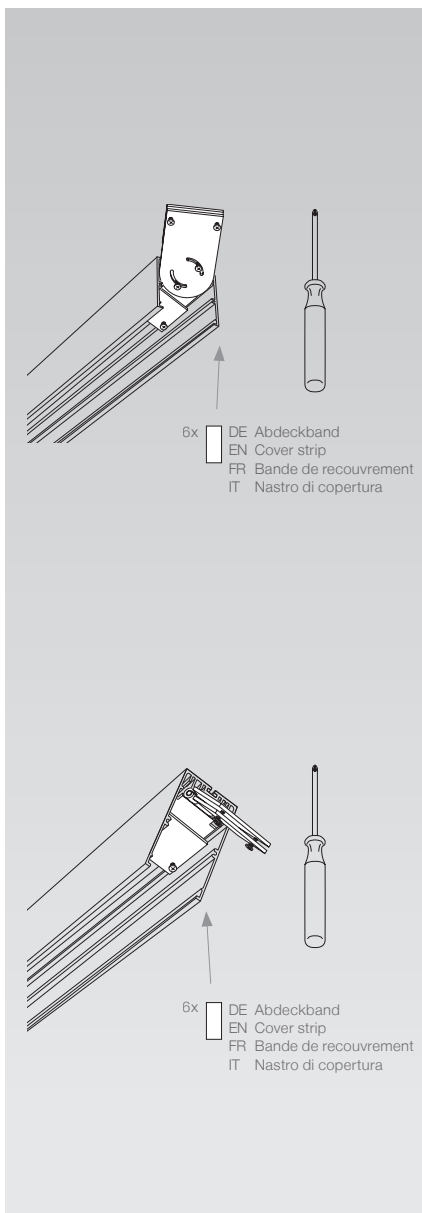
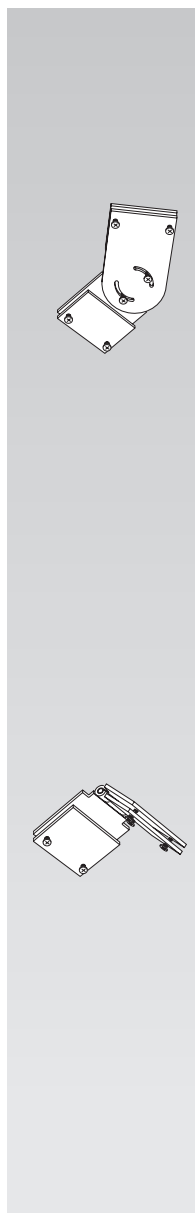

BAR Manual

MM01 17/10

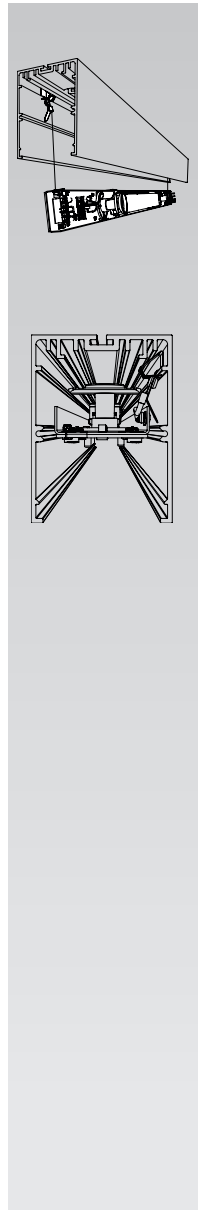
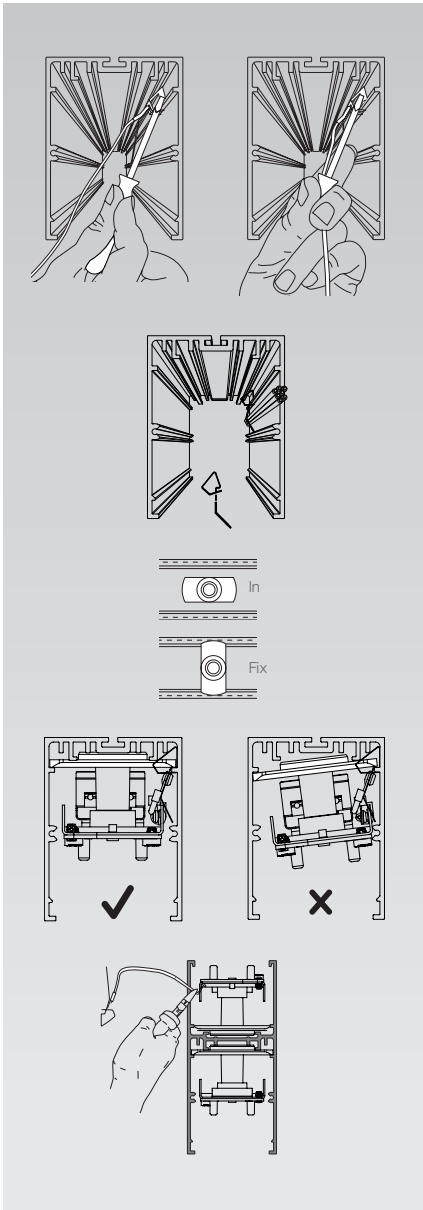
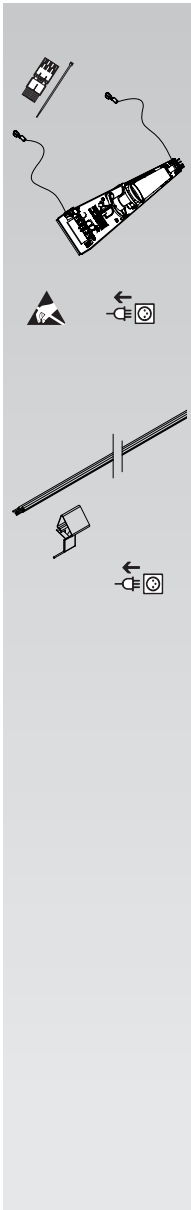

BAR Manual

MM01 17/10

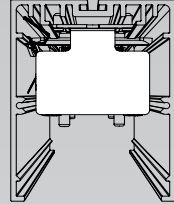
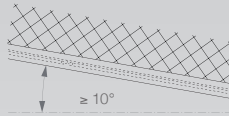
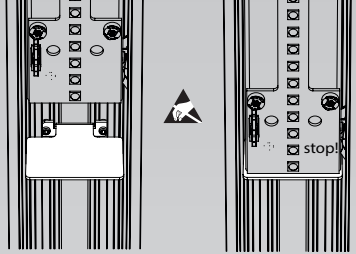
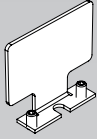

BAR Manual

MM01 17/10

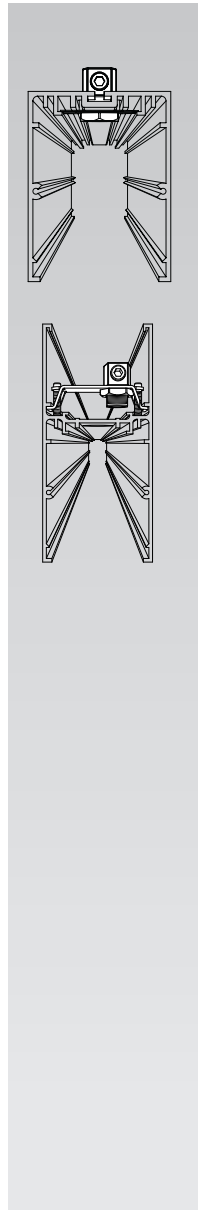
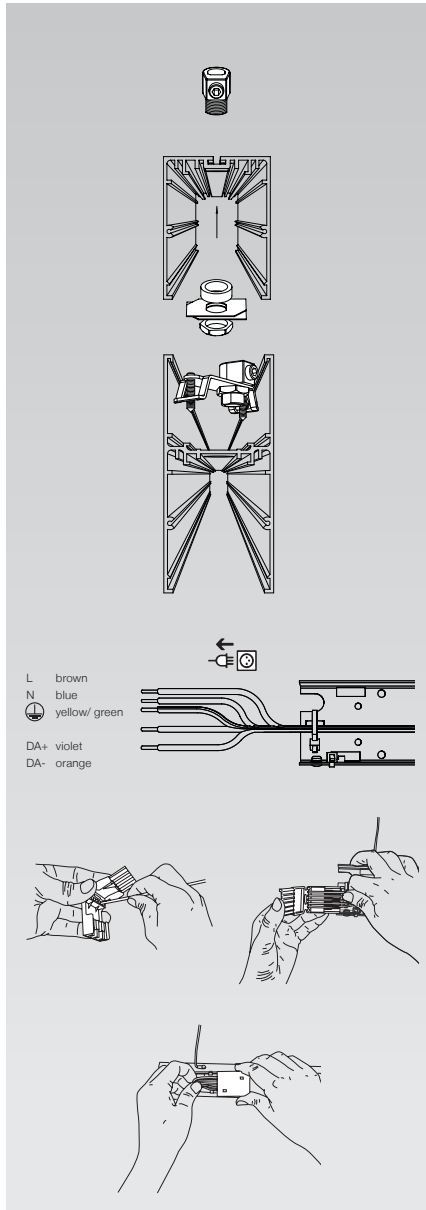
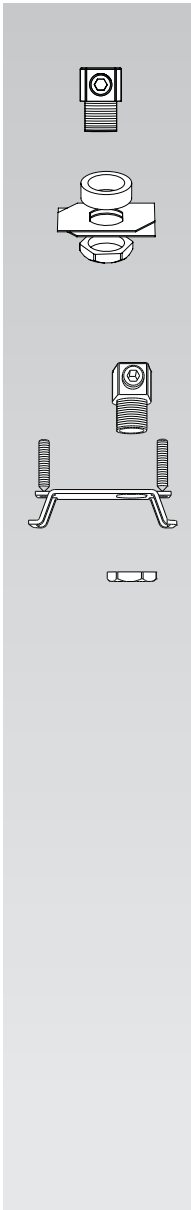

BAR Manual

MM01 17/10

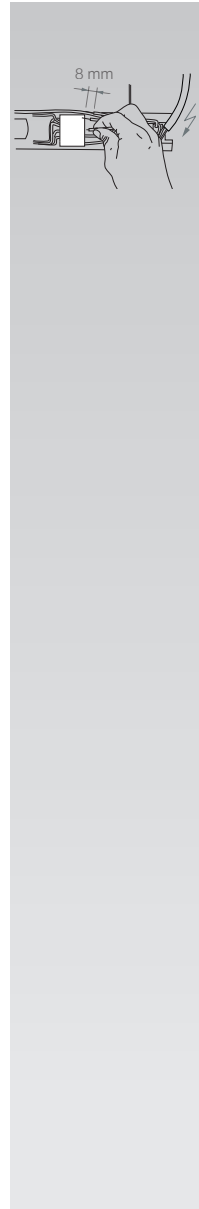
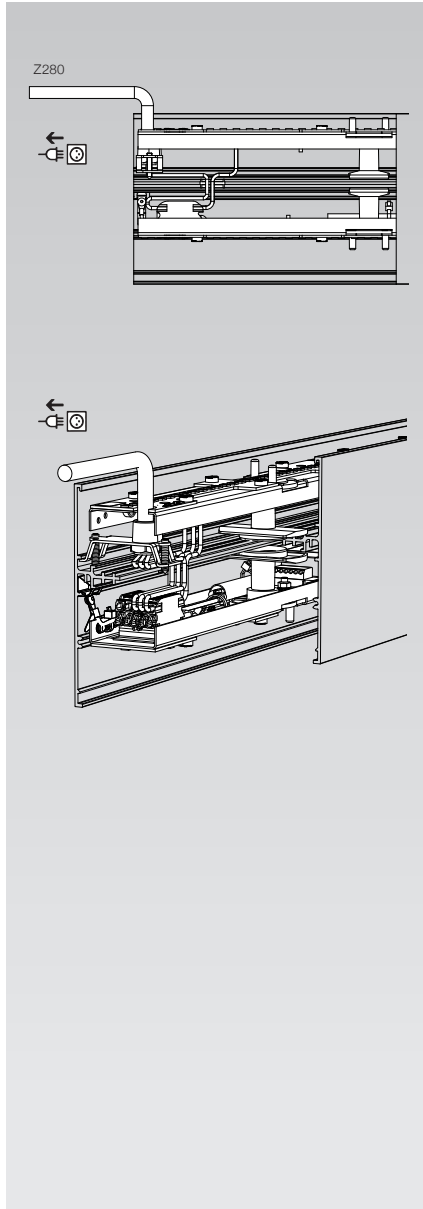
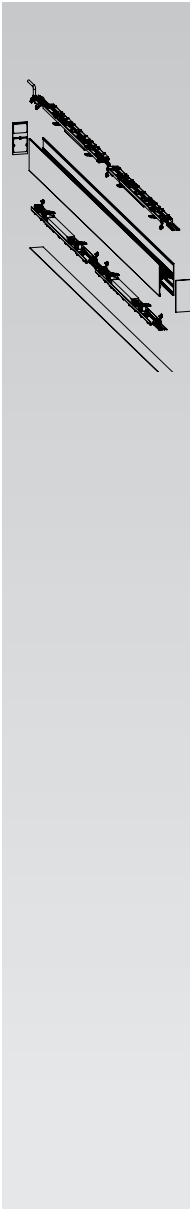

BAR Manual

MM01 17/10

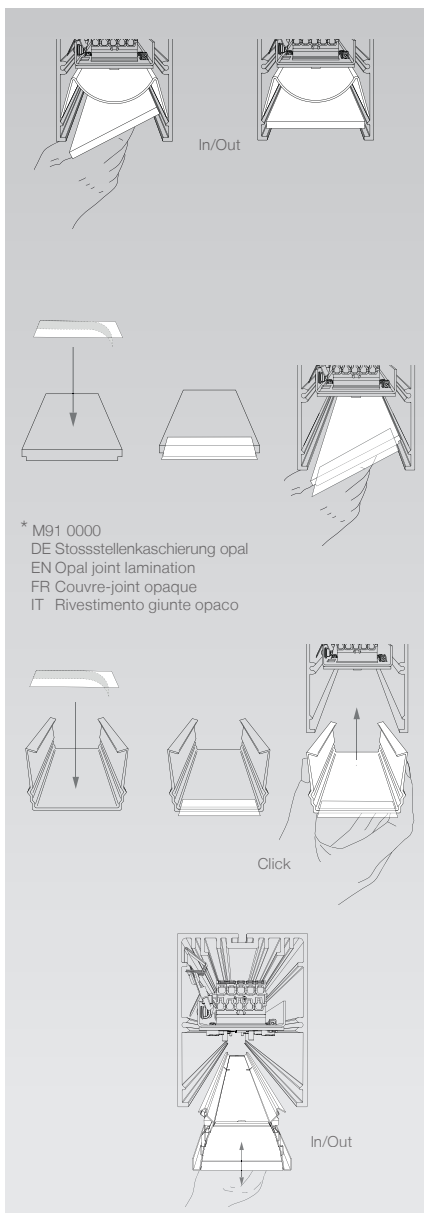
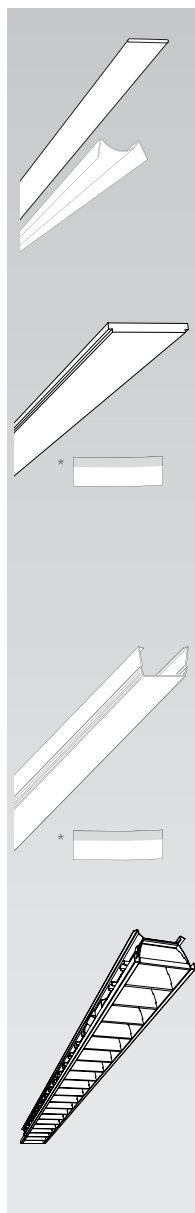

* M91 0000
 DE Stossstellenkaschierung opal
 EN Opal joint lamination
 FR Couvre-joint opaque
 IT Rivestimento giunte opaco

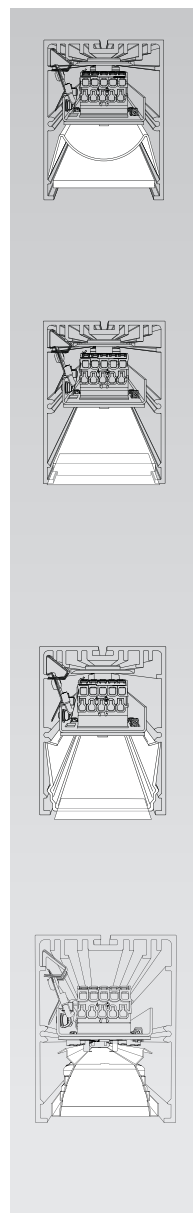

BAR Manual

MM01 17/10

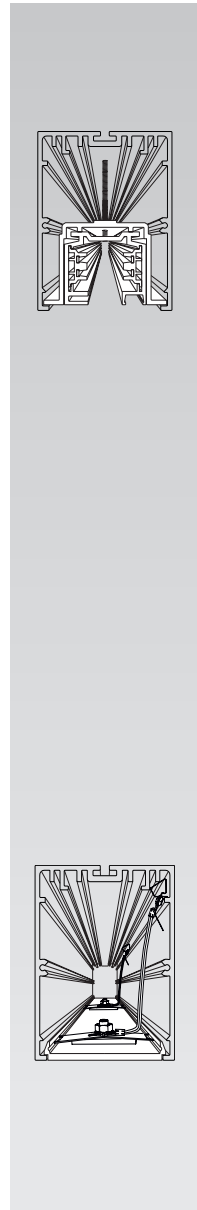
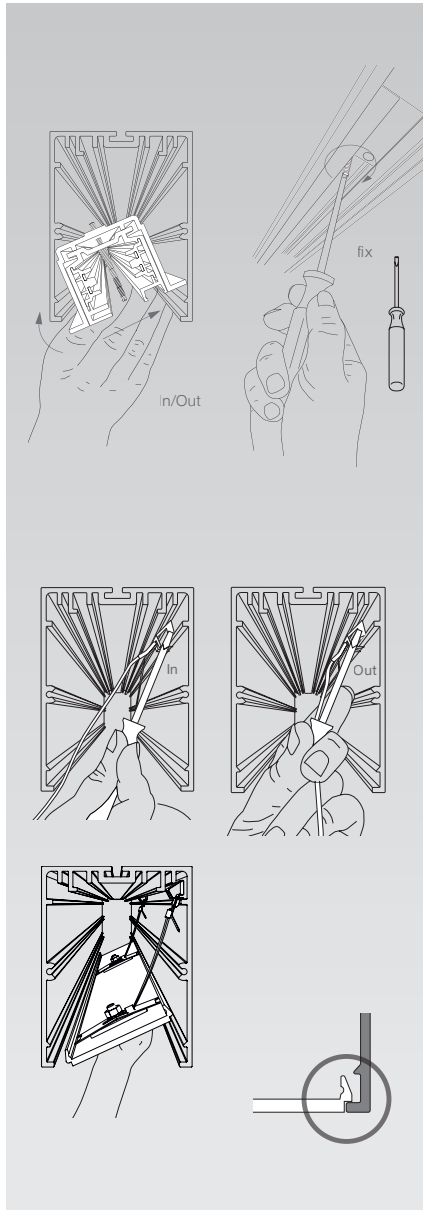
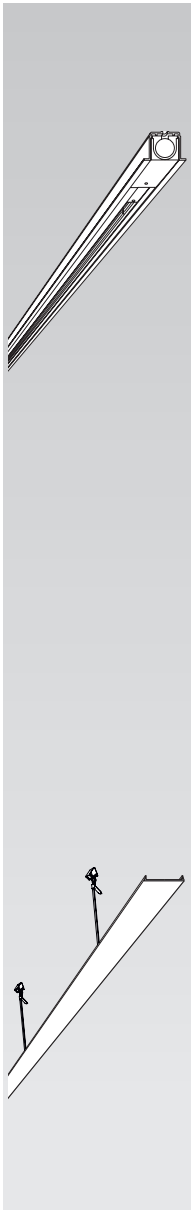

BAR FL Manual

MM01 17/10

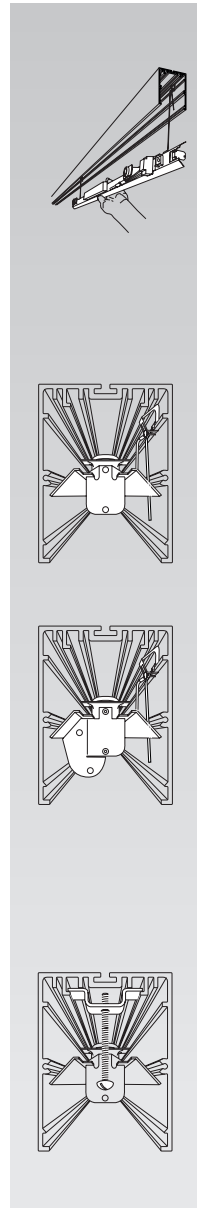
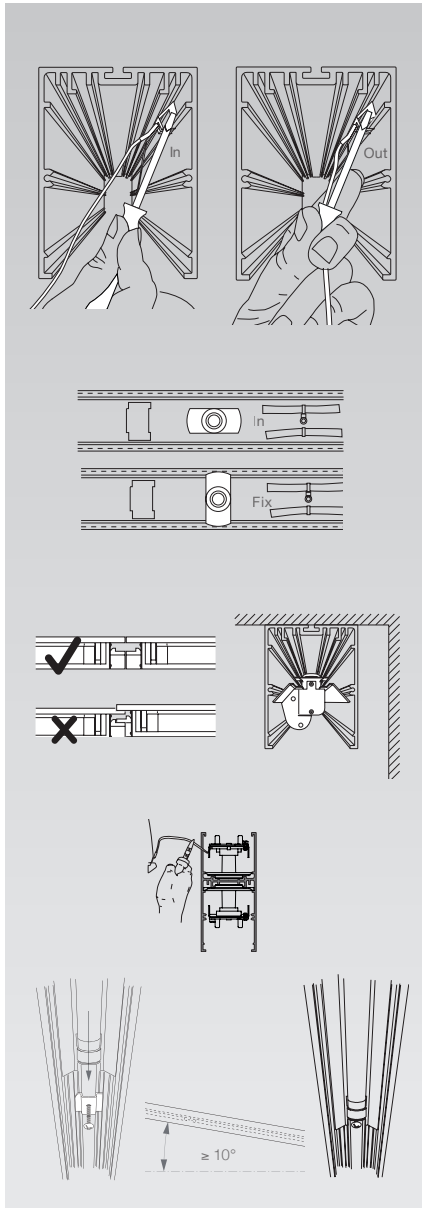

BAR FL Manual

MM01 17/10

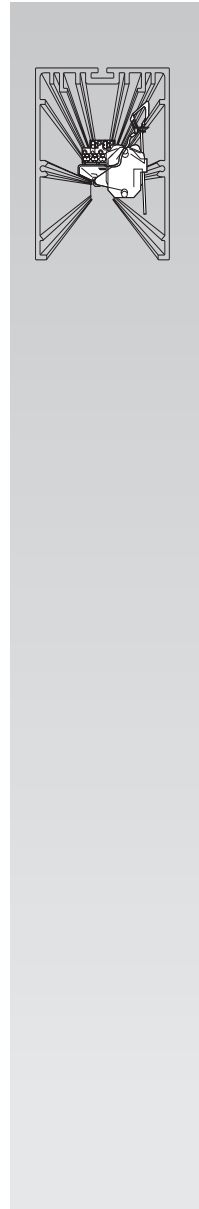
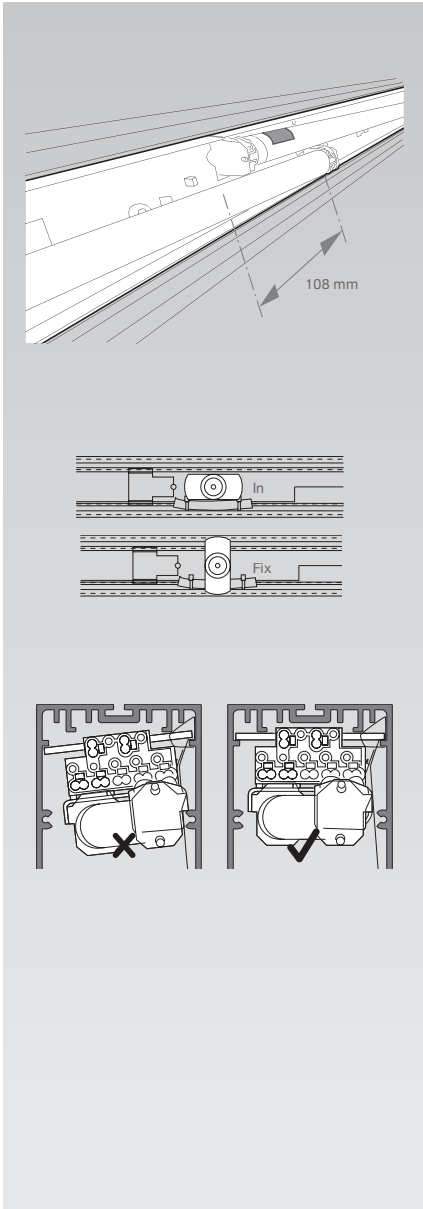
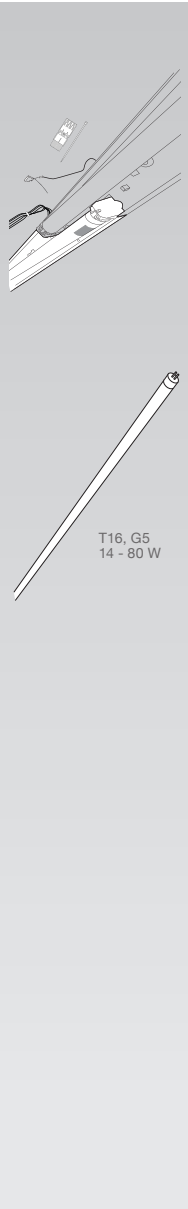

BAR FL Manual

MM01 17/10

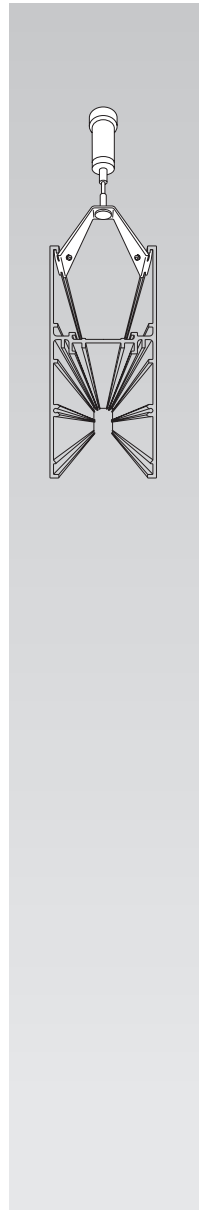
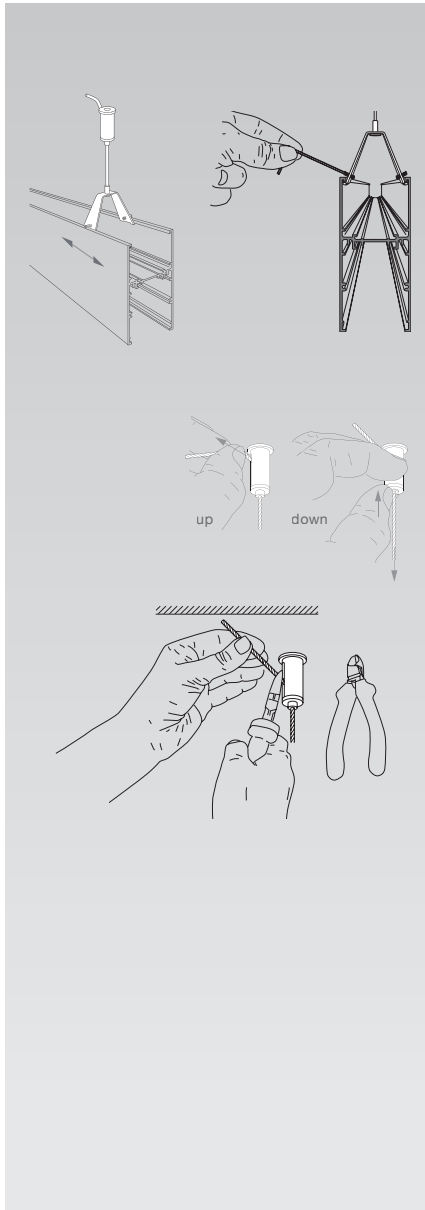
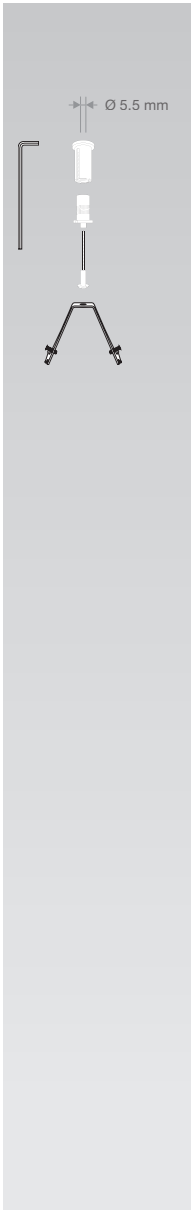

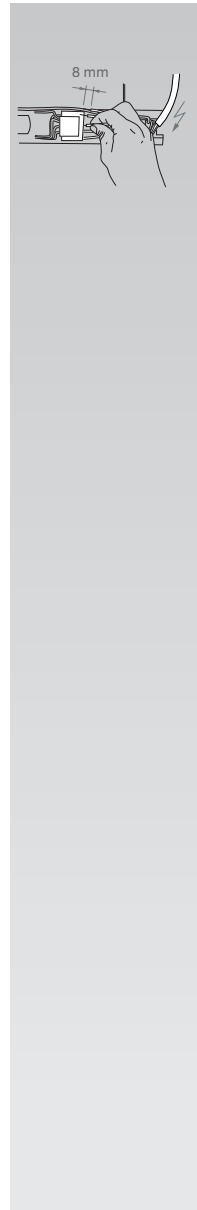
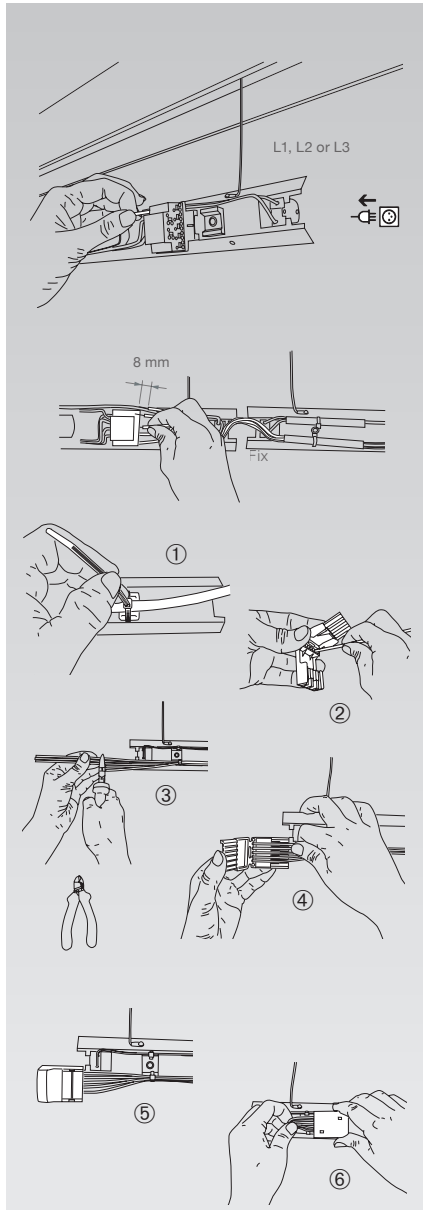
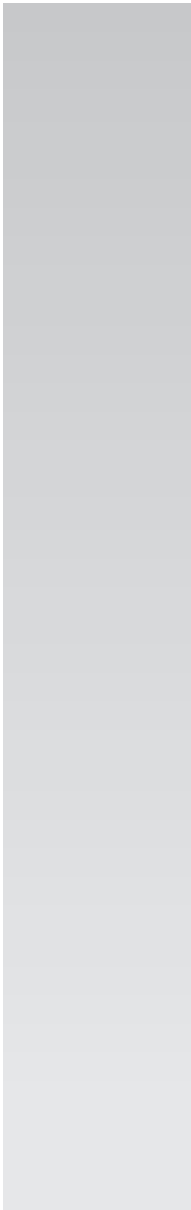

BAR FL Manual

MM01 17/10

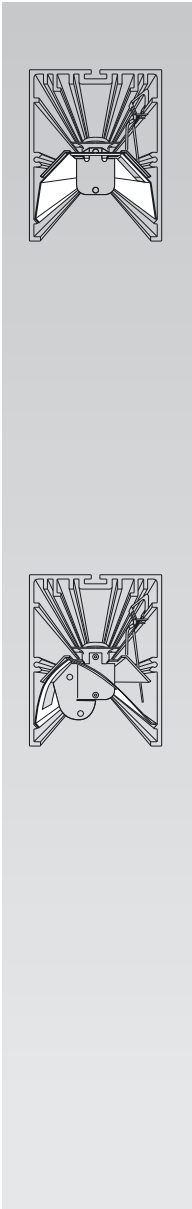
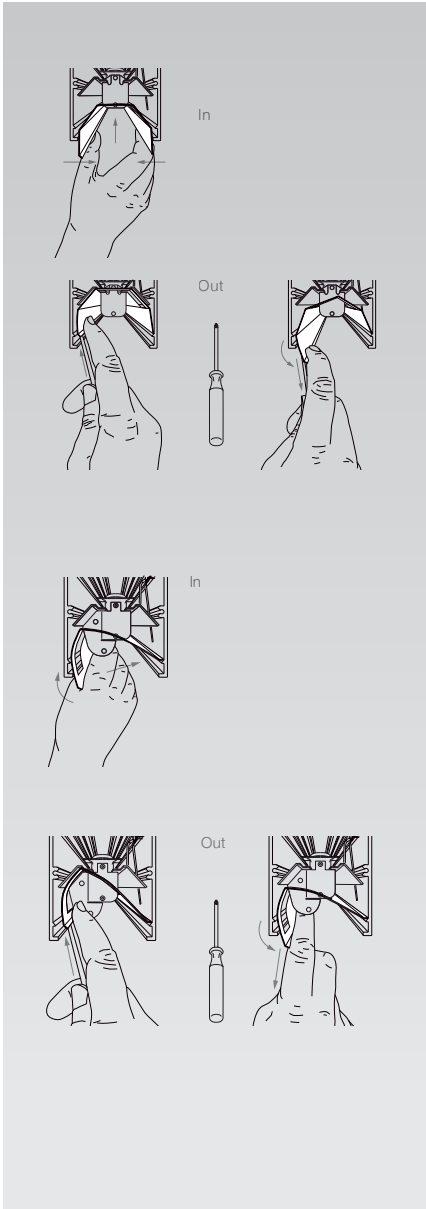
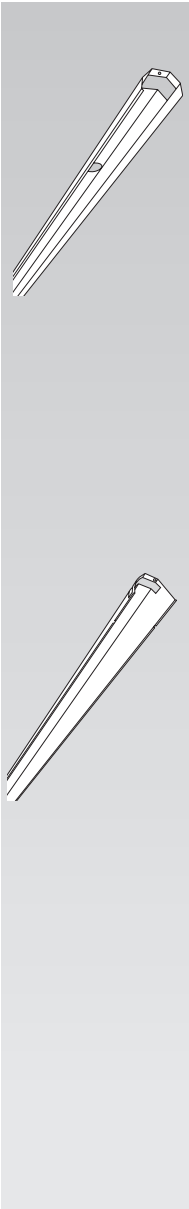

BAR Manual

MM01 17/10

DE Allgemeine Informationen

Bei der Montage sind die nationalen Installations- und Unfallverhütungsvorschriften, sowie die Warnhinweise ESD-Schutzmassnahmen zu beachten.

Reinigung

Reinigung der Leuchte: Die Reinigung der Kunststoffteile ist mit einem weichen Tuch und ggf. mit einem handelsüblichen, pH-neutralen, nicht scheuernden Reinigungsmittel vorzunehmen.

Warnhinweise

Zur Vermeidung von Gefährdungen darf eine beschädigte, äussere, flexible Leitung dieser Leuchte ausschliesslich vom Hersteller, seinem Servicevertreter oder einer vergleichbaren Fachkraft ausgetauscht werden.

EN General information

For installation, observe the statutory installation and safety regulations and the warnings regarding electrostatic discharge.

Cleaning

Cleaning the luminaire: Clean the plastic parts with a soft cloth and a conventional, neutral and non-abrasive detergent.

Warnings

For safety reasons, damaged, exposed flexible cables of this luminaire must be replaced by the manufacturer, an authorised service agent or a suitably qualified electrician.

FR Informations générales

Lors du montage, observer les normes nationales d'installation et de prévention des accidents ainsi que les consignes relatives aux mesures de protection ESD.

Entretien

Entretien du luminaire: l'entretien des parties en plastique doit être effectué avec un chiffon souple et éventuellement avec un produit nettoyant classique disponible dans le commerce, à pH neutre, non abrasif.

Avvertissements

Pour éviter tout danger, une ligne flexible, extérieure, endommagée, de ce luminaire peut être remplacée uniquement par le fabricant, son représentant pour l'assistance ou par une main d'œuvre spécialisée équivalente.

IT Informazioni generali

Nel montaggio occorre osservare le prescrizioni nazionali di installazione e prevenzione degli infortuni nonché le avvertenze relative alle misure di protezione ESD.

Pulizia

Pulizia della lampada: La pulizia delle parti in plastica deve essere eseguita con un panno morbido ed eventualmente con un detergente comunemente disponibile in commercio, con pH neutro, non abrasivo.

Avvertenze

Per evitare qualsiasi pericolo, una linea flessibile, esterna, danneggiata, di questa lampada può essere sostituita esclusivamente dal costruttore, il suo rappresentante per l'assistenza oppure da manodopera specializzata, equivalente.



- DE Leuchten der Schutzklasse I – mit Schutzleiteranschluss.
- EN Luminaires of Insulation Class I – with earth connector.
- FR Luminaires de classe de protection I – avec raccordement pour conducteur de protection.
- IT Classe I: La protezione è data esclusivamente dall'isolamento principale.

IP20

- DE Schutz gegen Eindringen von festen Fremdkörpern über Ø 12mm.
- EN The fitting is protected against penetration by solid bodies of over Ø 12mm.
- FR Protégé contre la pénétration de corps solides de plus de Ø 12mm.
- IT L'apparecchio è protetto contro la penetrazione di corpi solidi di dimensione superiore a Ø 12mm.



- DE Nur für den Gebrauch in Innenräumen.
- EN This product is designed for indoor use only.
- FR Ce produit est conçu uniquement pour une utilisation intérieure.
- IT L'apparecchio è previsto solo per uso interno.



- DE Elektrostatisch gefährdete Bauelemente.
- EN Static Sensitive Devices.
- FR Circuits sensibles à l'électricité statique.
- IT Dispositivi sensibili alle scariche elettrostatiche.



- DE Leuchte spannungslos schalten.
- EN Disconnect lamp from the power supply.
- FR Brancher les luminaires hors tension.
- IT Accendere l'apparecchio in assenza di tensione.



- DE Nicht über den Hausmüll entsorgen, sondern ordnungsgemäss dem Recycling zuführen.
- EN Do not dispose as household waste, but make the proper recycling.
- FR Ne doit pas être jeté dans la poubelle, veuillez utiliser un centre de recyclage approprié.
- IT Non gettare nei rifiuti domestici, ma effettuare il corretto riciclaggio.

DE Die Produkte-Abbildungen und Beschreibungen entsprechen dem Stand zum Zeitpunkt der Drucklegung. Technische, formale oder massliche Änderungen sowie Irrtümer sind vorbehalten **EN** The product images and description correspond to the state at time of printing. Technical, formal or dimensional information are subject to change **FR** Les illustrations et descriptifs correspondent aux spécifications en vigueur lors de l'impression. Des corrections techniques, formelles et dimensionnelles pourront être apportées ultérieurement **IT** Le figure dei prodotti e le descrizioni corrispondono allo stato al momento della stampa. Fatte salve eventuali modifiche tecniche, formali o dimensionali nonché eventuali errori.